

Obstacle 1

KOIVIKKO

Class 4; 5
Gates A; B; C; F

Class 1; 2; 6; 7; 8; 9
Gates A-E

Class 10; 11; 12
Gates A-F



● X 4 - dislodgeable element

YPÄJÄ 2023

05.08.2023.

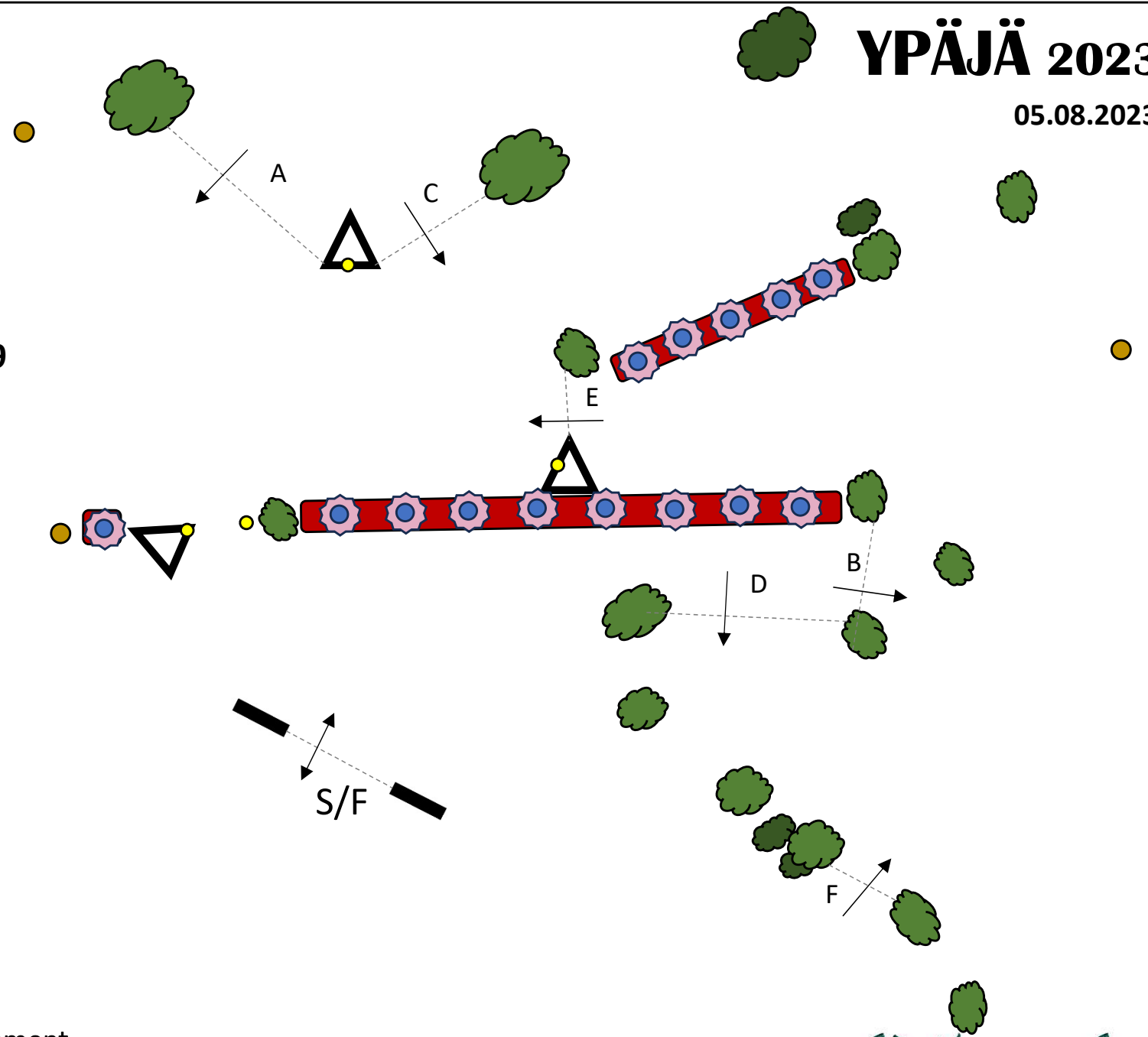

CD KRISTAPS CAUNE

Obstacle **2** KIVIAHO

Class 4; 5
Gates A-D

Class 1; 2; 6; 7; 8; 9
Gates A; B; C; D; F

Class 10; 11; 12
Gates A-F

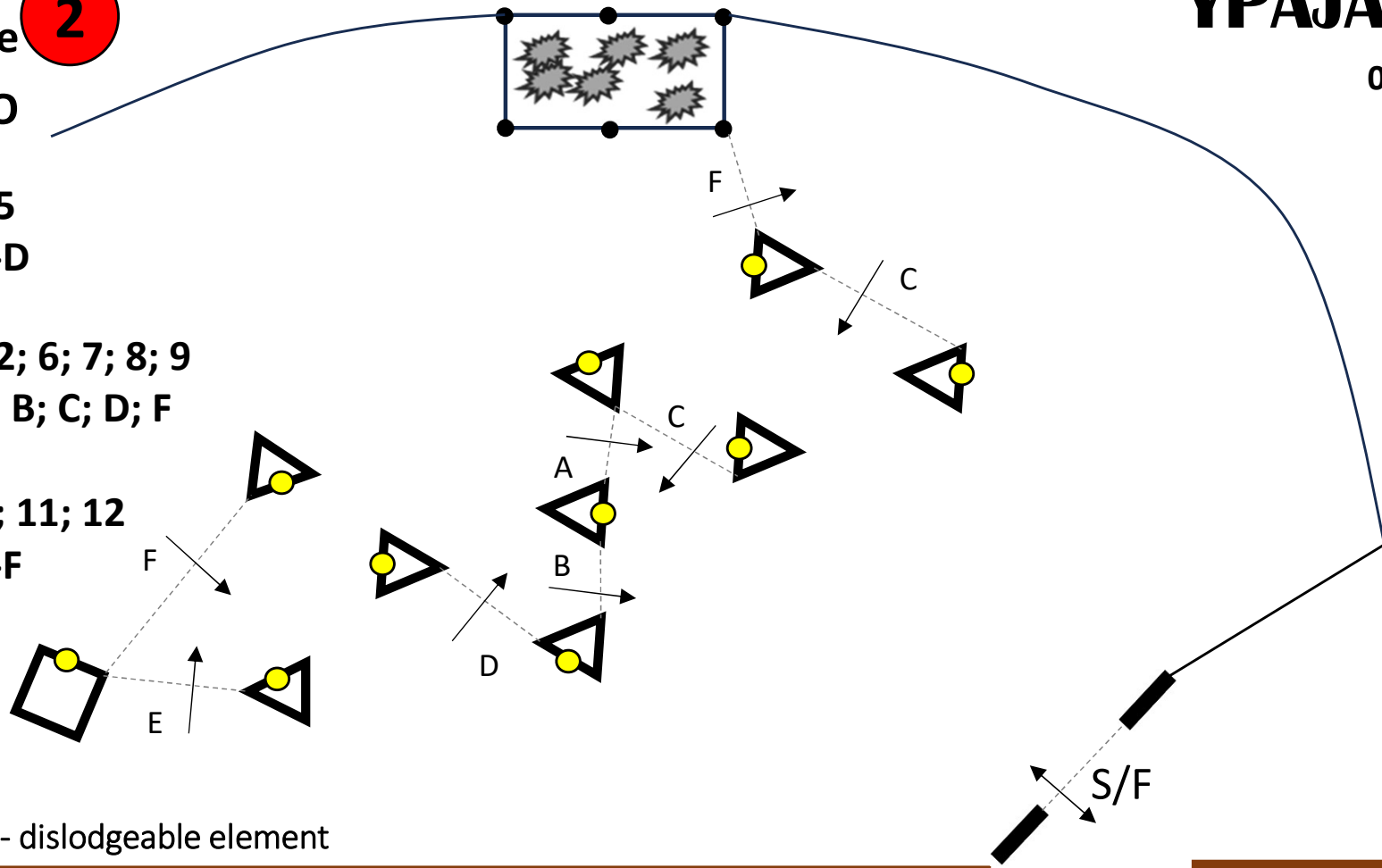

● X 10 - dislodgeable element

Lemmikkisi parhaaksi



www.roviovet.fi



www.roviopetfoods.fi

CD KRISTAPS CAUNE

Obstacle

3

YPÄJÄ 2023

05.08.2023.

RINNE

Class 2; 7; 9

Gates A; B; C; E; F

Class 10; 11; 12

Gates A-F

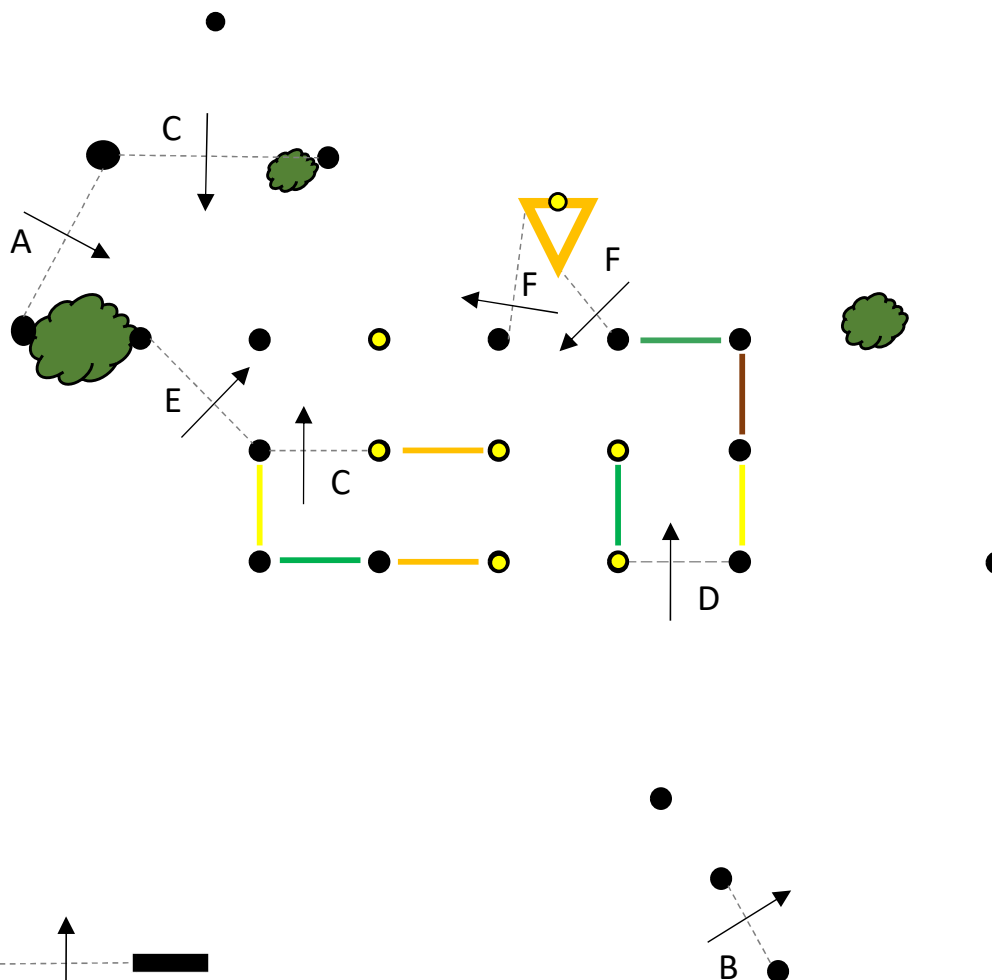

Lantmännen

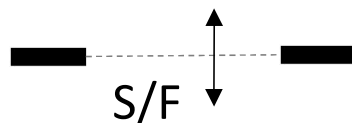

● X 7 - dislodgable element

CD KRISTAPS CAUNE

Obstacle

4

VESI

Class 1; 2; 6; 7; 8; 9

Gates A; B; C; E; F

Class 10; 11; 12

Gates A-F



YPÄJÄ 2023

05.08.2023.

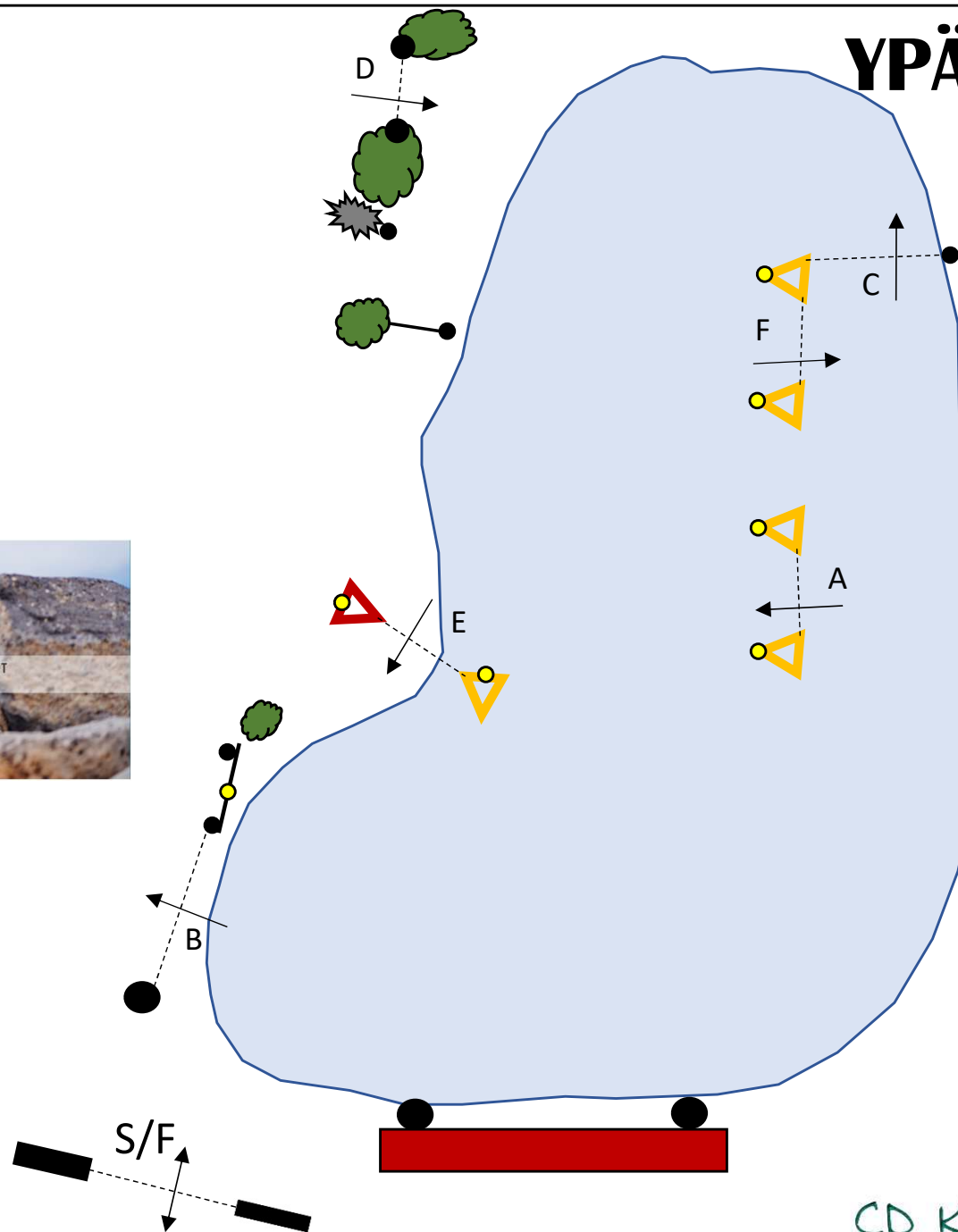

● X 7 - dislodgable element

CD KRISTAPS CAUNE

Obstacle **5**

RUOKINTAPAIIKKA

Class 4; 5

Gates A-D

Class 1; 2; 6; 7; 8; 9

Gates A; B; C; D; F

Class 10; 11; 12

Gates A-F

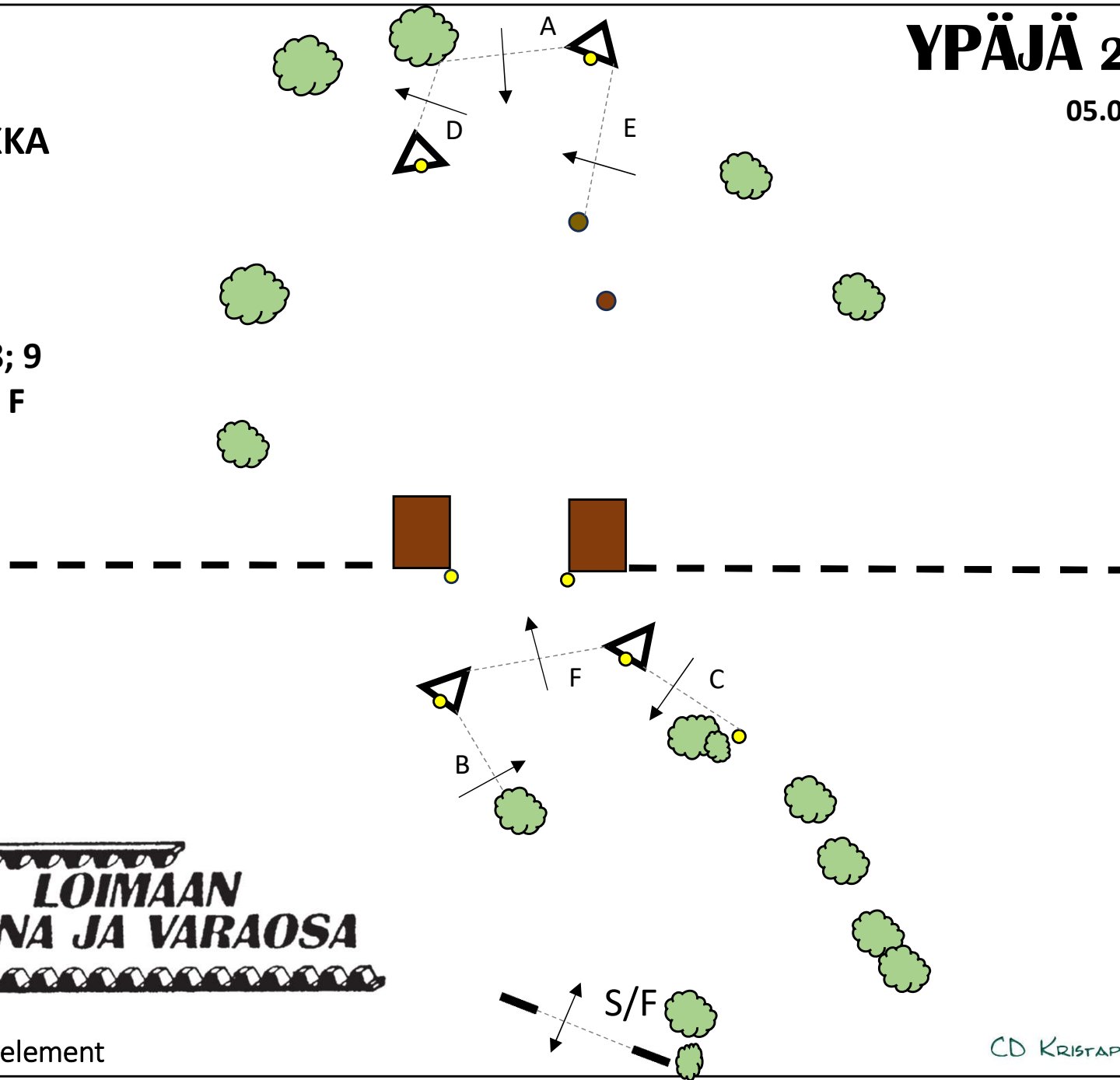

● X 7 - dislodgable element

Obstacle

6

MUURI

Class 11; 12

Gates A-F

YPÄJÄ 2023

05.08.2023.

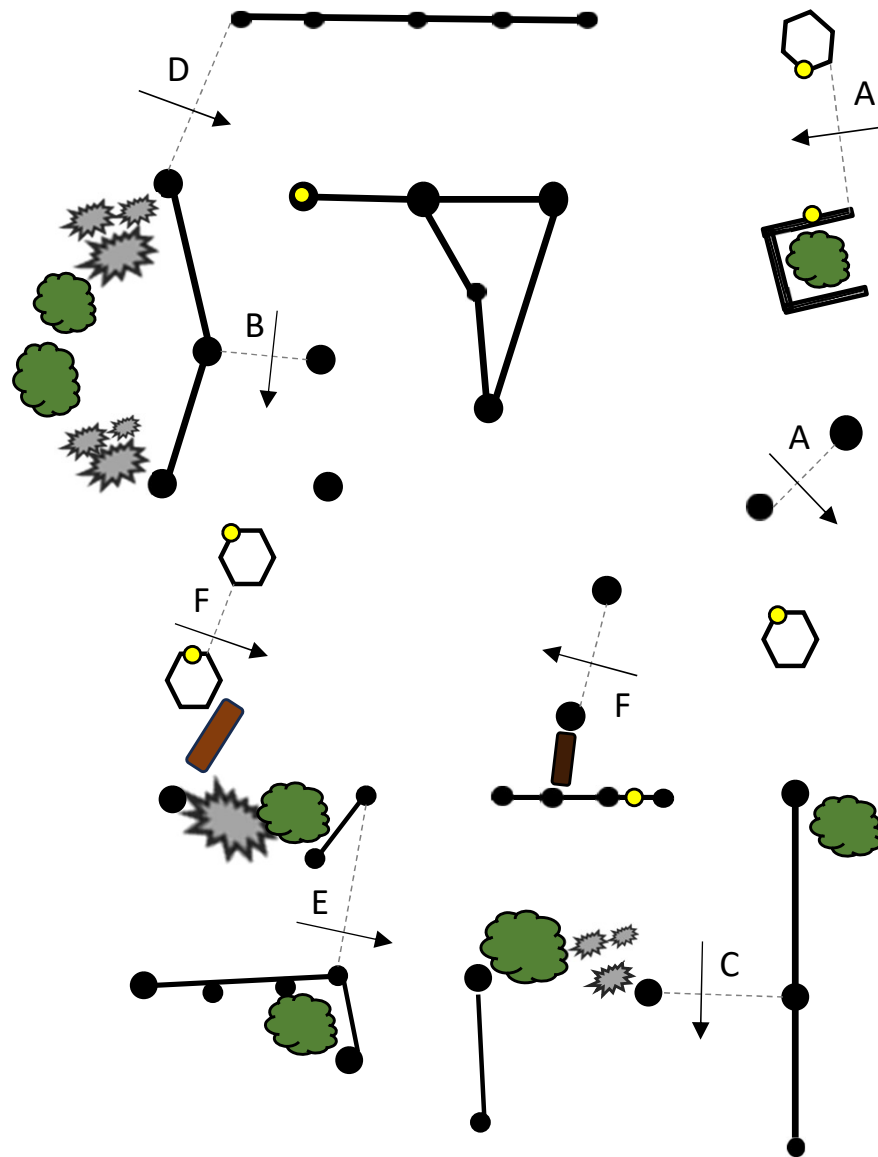

● X 7 - dislodgeable element

CD KRISTAPS CAUNE

Obstacle **7**

K-RAUTA

Class 4; 5

Gates A; B; D; F

Class 1; 2; 6; 7; 8; 9

Gates A; B; C; D; F

Class 10; 11; 12

Portit A-F

YPÄJÄ 2023

05.08.2023.

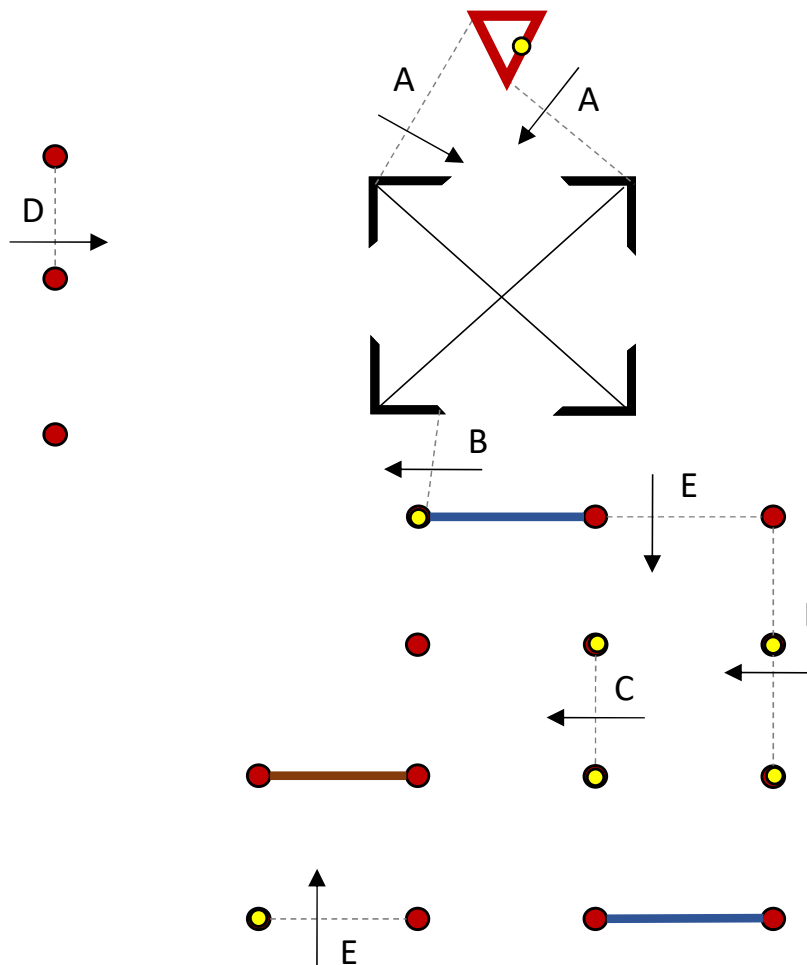

● X 7 - dislodgable element

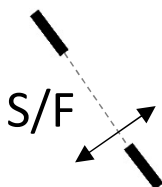

CD KRISTAPS CAUNE